

PARAGON OWNERS MANUAL

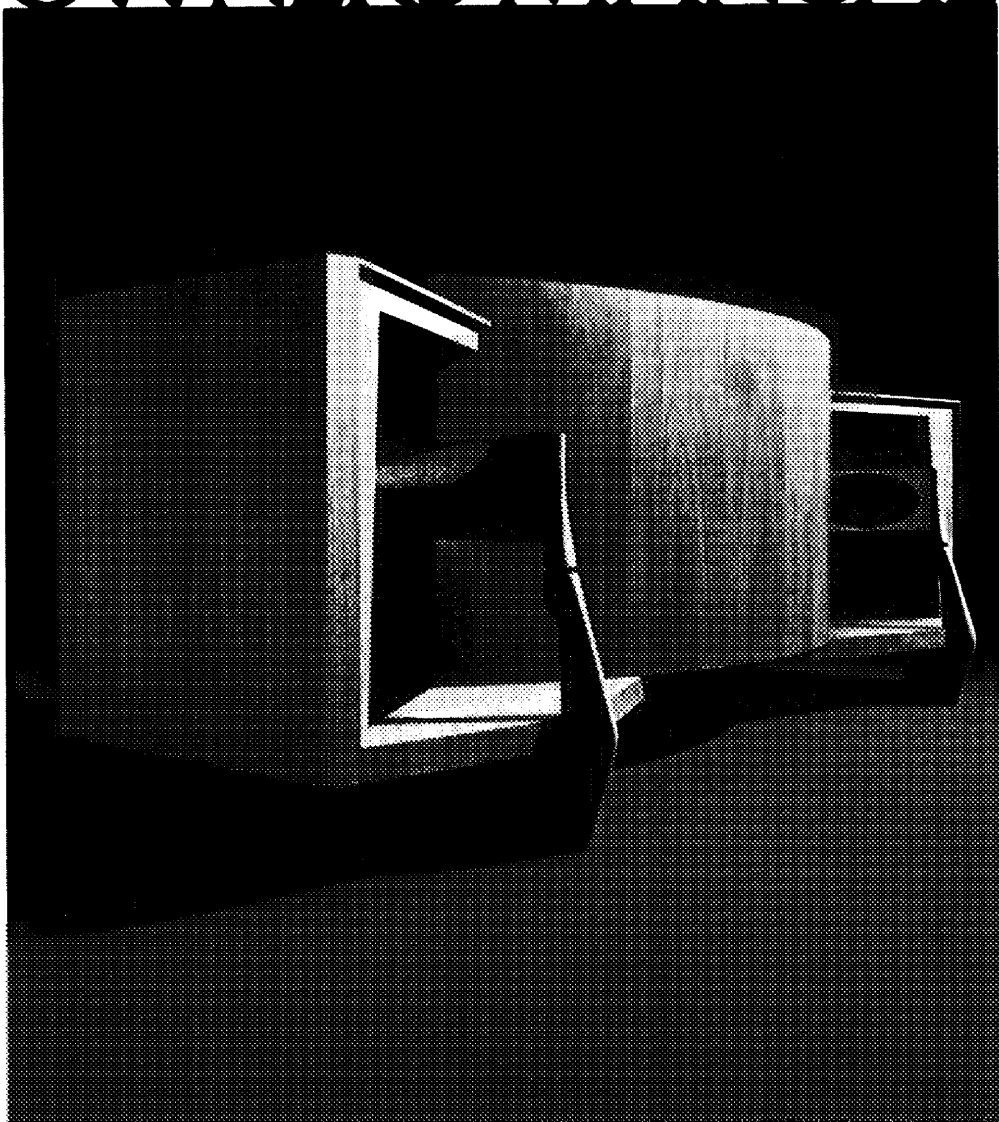

CONTENTS

The Paragon	1
Specifications	2
Placement	2
Assembling the Enclosure	3
Connecting the Paragon	4
Adjusting the System	5
Component Removal	7
The Paragon Enclosure	9
In Case of Trouble	10
Service	11
For Additional Information	12

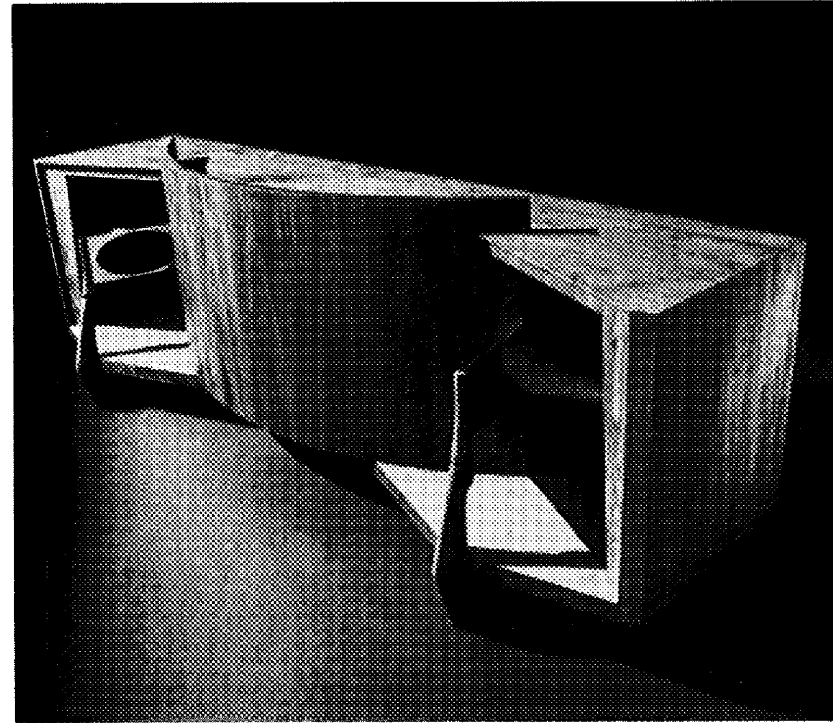

JBL continually engages in research related to product improvement. New materials, production methods and design refinements are introduced into existing products without notice as a routine expression of that philosophy. For this reason, any current JBL product may differ in some respect from its published description but will always equal or exceed the original design specifications unless otherwise stated.

The Paragon is a unique and classic loudspeaker system; one of the few loudspeakers in the world with an acoustic design so innovative that it was granted a United States patent. It may well be the most expensive loudspeaker ever produced for home use. Since its introduction in 1957, the acoustic and visual excellence of the Paragon have become legendary. Perhaps the most meaningful evidence of this is the fact that it continues to be purchased in ever increasing numbers. Despite growing popularity, however, building a Paragon still involves the same unhurried and elaborate processes as always. JBL craftsmen devote more than 112 hours to the construction of each.

The Paragon's appearance reveals much about its performance. For example, the wide, convex panel on the front of the enclosure projects a continuously balanced stereophonic image to the listener—even when he is seated far off-axis from the loudspeaker. This precisely contoured panel is a major element of the patent which precludes others from duplicating the system without JBL's permission. The Paragon is impressively large. This suggests but does not fully convey the breadth and spaciousness of sound it produces as it fills a room with music in a manner remarkably similar to a live performance.

The enclosure features a 2.7 m (9 ft) expanse of prime walnut veneer, skillfully finished with an exclusive oil-wax formula and hand rubbed to perfection. Within the enclosure are JBL's finest component loudspeakers, each critically designed, machined and assembled to provide maximum performance—indefinitely.



Components listed are duplicated in each half of the Paragon.

Maximum Recommended Amplifier Power	200 watts per channel
Nominal Impedance	8 ohms
Dispersion	120°
Crossover Frequencies	500 and 7000 Hz
Sensitivity	95 dB SPL, 1 W, 1 m (3.3 ft)
Low Frequency Loudspeaker	
Nominal Diameter	380 mm 15 in
Voice Coil	100 mm (4 in) edgewound copper ribbon
Magnetic Assembly Weight	10.3 kg 22½ lb
Flux Density	0.95 tesla (9500 gauss)
Sensitivity ¹	95 dB SPL, 1 W, 1 m (3.3 ft)
Midrange Compression Driver	
Throat Diameter	50 mm 2 in
Voice Coil	100 mm (4 in) edgewound copper ribbon
Magnetic Assembly Weight	10.7 kg 23½ lb
Flux Density	1.5 tesla (15,000 gauss)
Sensitivity	118 dB SPL, 1 W, 1 m (3.3 ft)
High Frequency Ring Radiator	
Nominal Diameter	98 mm 3⅞ in
Voice Coil	44 mm (1¾ in) copper
Magnetic Assembly Weight	1.5 kg 3¼ lb
Flux Density	1.65 tesla (16,500 gauss)
Sensitivity (averaged above 4 kHz)	110 dB SPL, 1 W, 1 m (3.3 ft)
Finish	Oiled Walnut
Dimensions	902 mm x 2632 mm x 614 mm deep 35½ in x 103⅝ in x 24⅙ in deep
Shipping Weight	317 kg 698 lb

¹Since the major portion of the energy reproduced by the low frequency loudspeaker lies below 500 Hz, this specification has been developed by using a test signal warbled from 100-500 Hz, rather than the conventional 1-kHz sine wave test signal on which the EIA sensitivity rating is based.

PLACEMENT

Due to the Paragon's special acoustic characteristics, performance is virtually the same regardless of room placement. However, if the listening room is unusually "live" and consists primarily of hard, reflective surfaces such as large, exposed windows, paneled walls and hard wood floors and ceilings, sound quality may be adversely affected through the loss of clarity. To improve the acoustic characteristics

of such rooms, it is wise to place drapes, tapestries, bookshelves or similar items on the wall behind the listeners.

ASSEMBLING THE ENCLOSURE

The Paragon is shipped in three parts; the left- and right-hand halves of the enclosure and the convex refractor panel. The two legs located at the front of the enclosure are adjusted and locked at the factory. The four legs located at the rear of the enclosure should be adjusted by the user at the position occupied by the system in the room.

After establishing where the system will be permanently located, the two main enclosure sections can be leveled by adjusting the two outer legs to approximately the correct height; then, push each enclosure section together so that the dowel pins on one side fit into the corresponding holes in the other. A minor readjustment of the two outer legs is usually required to obtain a perfect fit. When the enclosure sections are properly mated, the legs should be secured in position by the locknuts provided.

The two enclosure sections are semi-permanently locked together by six wedge brackets: three in the front and three in the rear.

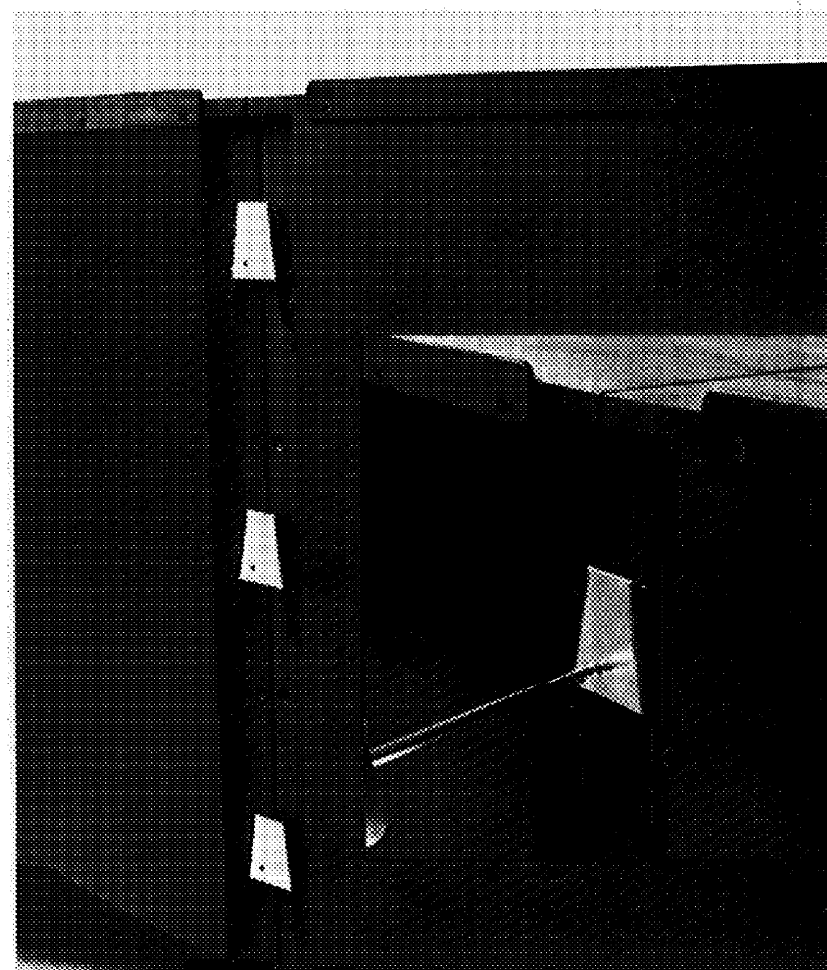

Fit the wedge clips over each bracket and drive them into place by tapping downward with a small hammer. Insert a single wood screw through the hole in each clip to hold it in position.

The curved refractor panel can now be set into place. This is most easily accomplished by two persons. Lower the panel from the top of the enclosure, sliding the edges through the notches at the ends of the curved cabinet sections. Take care to avoid scratching the surface of the midrange horns. When correctly positioned, the panel fits tightly and butts firmly against the top of the enclosure.

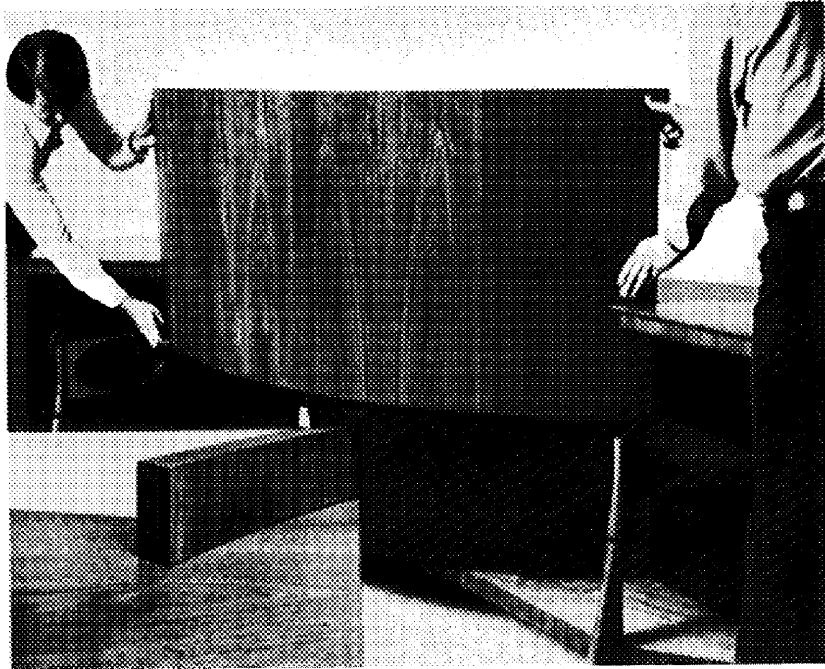

CONNECTING THE PARAGON

IMPORTANT: When connecting or disconnecting loudspeakers from an amplifier, the amplifier must be turned off. Making connections while the amplifier is operating could seriously damage the loudspeaker system and void the warranty.

For loudspeaker connections up to 15 m (50 ft) from the amplifier, 1 mm (#18 AWG) insulated wire (ordinary household lamp cord) is the minimum size recommended. Beyond this distance, heavier wire is desirable: 1.3 mm (#16 AWG) to 30 m (100 ft), and 1.6 mm (#14 AWG) to 60 m (200 ft). If lampcord is used, wires can be differentiated by noting that one of the insulating jackets is smooth, while the other has a distinct ridge. By considering the ridged jacketed "red" and the smooth jacketed "black," wiring connections can be made as if using color-coded wire.

Connections to the audio power source are made using the four pushbutton terminal posts located on the back of the Paragon enclosure. The holes in JBL terminal posts do not allow the connecting wire to pass all the way through, preventing the possibility of a short to the other terminal post or to nearby electrical conductors.

To make a secure connection, strip approximately 1/4 inch of the insulation from the end of the wire, push down the spring-loaded terminal post cap, insert the bare wire into the exposed opening of the terminal post and release. (Insertion of the wire into the opening will be easier if the stripped

wire is first tinned with a soldering tool and solder.)

Locate the loudspeaker output terminals on the back of the receiver or power amplifier. For each loudspeaker system, connect the wire from the black terminal post to the amplifier output terminal labeled "common," "ground" or "(-)", and the wire from the red terminal post to the remaining 8-ohm speaker output.

Note that many amplifiers have a chassis grounding terminal which is usually isolated from the other connectors. This should not be confused with the "ground" designation sometimes used to describe two of the terminals in each set of loudspeaker connections.

The specified 8-ohm impedance rating is a nominal figure which suggests a connection giving the most efficient power transfer between amplifier and loudspeaker system. However, 4- or 16-ohm amplifier terminals can be used without danger.

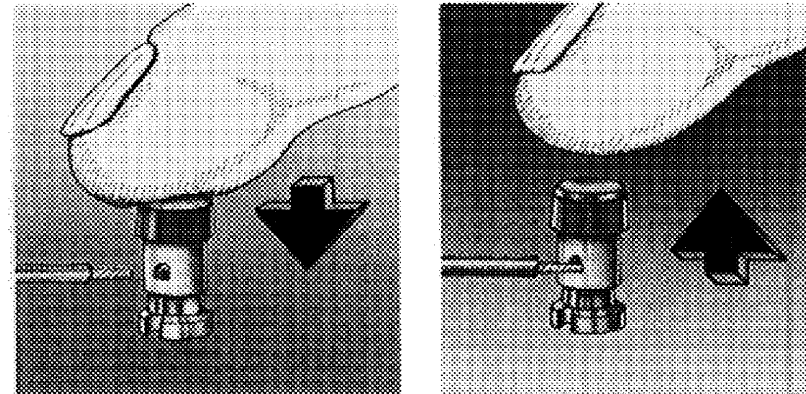

1. Depress colored button, exposing hole in terminal post.
2. Push stripped end of lead wire into hole and release button. Never apply twisting force to the terminal post.

Under most conditions, the three position switch on each midrange dividing network (LX5) should be placed in the MED (medium) position. The continuously variable control on the high frequency dividing networks (N7000) should be rotated until the number four on the control knob is at approximately the "12 o'clock" position. This is considered the normal position: with the controls set in this manner, a smooth tonal balance will be heard in the majority of listening rooms. However, in rooms that are either excessively reverberant or excessively "dead" acoustically, alternate settings of the network controls may be required.

Of course, even though the acoustics of a room may be ideal, personal listening preferences vary as do the sound characteristics of different types of playback equipment. Either of these general conditions may suggest settings other than those originally described.

Whether compensating for room acoustics or changing to suit personal listening preferences, the procedure for the initial balancing of the system is the same. Prior to changing the network settings, audition several selections from

ADJUSTING THE SYSTEM

favorite recordings. Recordings of solo voices are recommended because most listeners are able to perceive a voice that is improperly balanced much more easily than an orchestra presented with the same degree of imbalance. During the evaluation, amplifier tone controls should be set at their middle (typically referred to as "flat") position and the mode or equivalent selector switch in the monaural (L & R) position. The balance control should be placed full left or full right; and initial network adjustments made to that channel only. After adjustment, listen a short while then move the balance control to the opposite extreme. This will provide an instant comparison between the adjusted channel and the normal channel. The normal channel will serve as an excellent point of reference.

Actual adjustments should proceed as follows:

1. Check to see that the midrange control is switched to the MED position. Rotate the high frequency control to the extreme left of its travel. This attenuates high frequency output so that the ear hears only the balance between the low frequency and midrange loudspeakers.
2. Pay particular attention to the smoothness and naturalness of the voice. If it sounds too bright and over emphasized, switch the control to the MIN (minimum) position. If it sounds distant or slightly muffled, switch the control to MAX (maximum) position.
3. When the midrange dividing network has been satisfactorily adjusted, gradually increase the setting of the high frequency control until a pleasing overall balance has been achieved. In addition to voice, recordings having bells, cymbals and triangles are also useful for this test.

After each adjustment, listen to two or three different recordings. This gives a broader base on which to make judgments as to the best setting of the controls. When final settings have been determined on one channel, merely duplicate these settings on the remaining channel. Compensation

for differences in individual recordings should be made using the tone controls on the amplifier or receiver.

COMPONENT REMOVAL

Mounting positions of individual components are shown in the illustration below. If it should become necessary to remove the loudspeaker system components for testing or repair, disconnect the Paragon from the amplifier and proceed as outlined below.

LOW FREQUENCY Remove the 16 Phillips-head screws from the panel at the rear of the enclosure. Carefully tilt the panel outward for access to the low frequency driver and detach the wire leads from the driver. Holding the loudspeaker firmly, remove the four screws that attach it to the baffle board. If the loudspeaker gasket adheres to the baffle, gently separate it using a sturdy, broad-bladed tool such as a putty knife. In severe cases, a large screwdriver may be required. Take care to avoid unnecessarily damaging the gasket.

MIDRANGE DRIVER AND HORN Remove the upper section of the sculptured front leg by firmly pulling it upward. Next, unscrew the two Phillips-head machine screws that hold the front edge of the horn mouth to the mounting bracket. Remove the two Phillips-head machine screws which attach the rear edge of the horn mouth to the rear mounting bracket. Using a 1/8" Allen wrench, remove the four socket-head machine screws which fasten the midrange driver to the horn. Detach the wire leads located at the rear of the driver. Loosen the two 9/16" square nuts retaining the clamp assembly which holds the driver in place. The driver can now be removed by pulling it forward. When reinstalling the driver, make certain that its input terminals face toward the rear of the enclosure before mounting the horn in place. Do not clamp the driver into position until it has been attached to the horn and the front horn flanges are assembled to their respective brackets.

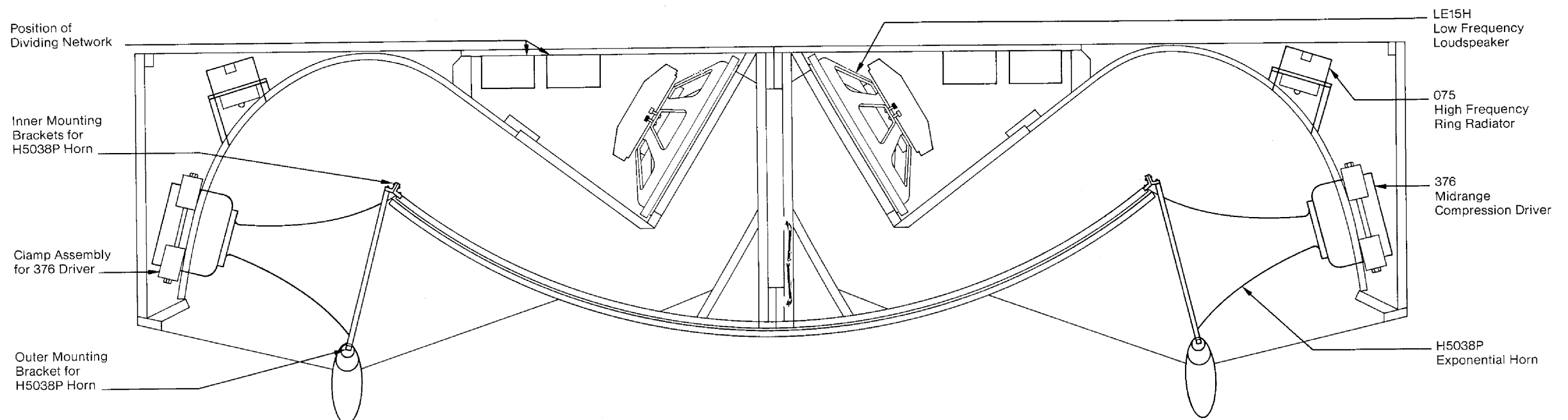

HIGH FREQUENCY The wire leads from the high frequency driver are accessible from the rear of the enclosure. After detaching these, the five Phillips-head wood screws that attach the driver's clamp ring to the baffle board should be removed. The driver is removed by loosening the screw at the bottom of the clamp ring. When reinstalling the high frequency driver, the two larger wood screws are inserted through the holes nearest the base of the clamp ring. The ring is positioned so that its base is directed towards the bottom of the enclosure.

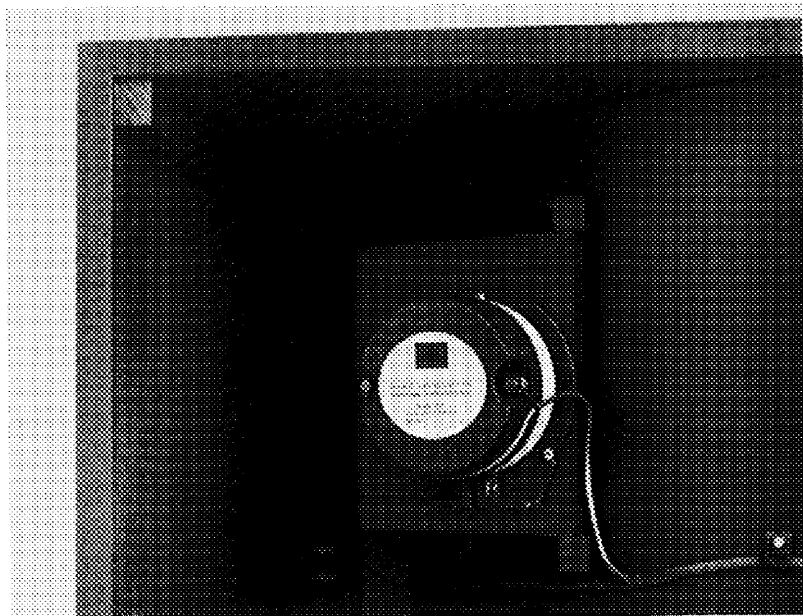

DIVIDING NETWORKS Detach the amplifier leads from the network terminals. Remove the four screws from the corners of each network mounting plate. Lift out each network and remove the wire leads by gently pulling them through the holes in the network mounting plate. Identify each wire so that it can be replaced in the proper hole when the network is reinstalled. Use the wiring diagram below to verify that connections have been properly made. Each channel is color-coded as shown.

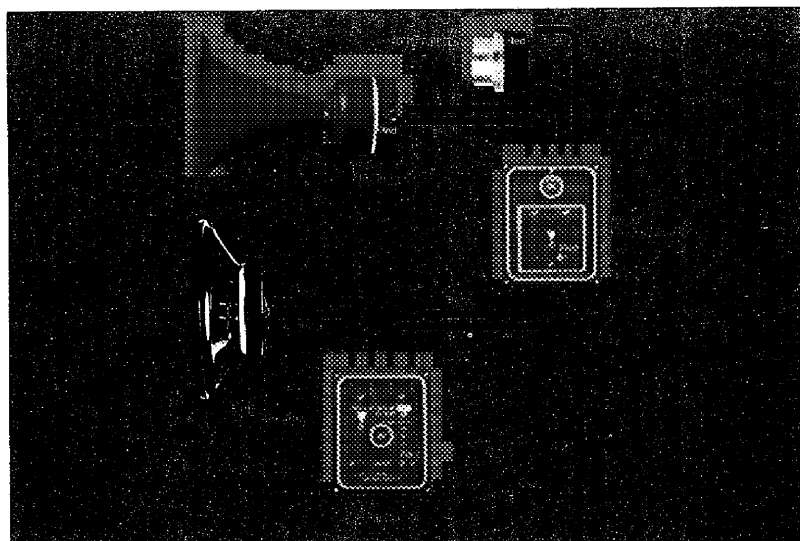

REPLACEMENT Reverse the removal procedure to replace the loudspeaker system components. Mounting screws should be tightened evenly to avoid the possibility of frame warpage, and just enough to prevent air leaks between the components and the enclosure. Avoid excessive force.

Although JBL loudspeakers are extremely rugged, the cone and other moving parts are subject to accidental damage. Exercise extreme caution whenever using a screwdriver or other tools in their immediate vicinity. Whenever the horn is removed from the compression driver, the mouth of the driver should be covered with plastic tape. An intense magnetic field exists in the mouth of the driver, and it is extremely important that foreign objects such as iron chips, mounting hardware, tools or other metal items be kept from the area.

JBL cabinetry represents the finest quality available in the high fidelity industry, uniquely styled and solidly constructed to last a lifetime. Designed to complement the characteristics of the loudspeaker components, the Paragon enclosure features tight, wood-welded, lock-mitered joints and acoustic padding to eliminate undesired resonance and warpage. Only the finest compressed woods, furniture hardwoods and hardwood veneers are used—carefully selected, skillfully prepared and hand-rubbed to a rich, lustrous finish enhancing the natural beauty of individual grain structure and color. Detail work is obvious: hand-fitted joints are expertly closed; edge veneering is flawless; scratches, dents, gluelines and other defects are non-existent. Typical assembly line procedures are avoided; each cabinet receives all of the personal attention it must have before it can bear the JBL medallion—the symbol for quality throughout the world.

THE PARAGON ENCLOSURE

Occasional dusting with a clean, soft cloth will maintain the original beauty of the oiled walnut enclosure. Since moisture cannot penetrate the oiled surface, most household stains can be easily removed with a damp cloth. The surface should be treated only with wax specifically formulated for use on oiled finishes. Conventional furniture waxes, polishes or cleaners are not recommended.

As the oil penetrates deeper and deeper into the walnut, the finish may appear to be drying out. Many owners find it desirable to re-oil the enclosure surface from time to time. With each application, the beauty of the finish will become more obvious, and a warm, rich patina will eventually be obtained.

To re-oil the finish, use the JBL finishing oil supplied with the Paragon or any one of the several clear oil finishing preparations available through furniture or hardware outlets. Apply a liberal amount of the preparation over the entire finished surface of the enclosure. In ten to fifteen minutes wipe off the remaining oil with a soft, clean, dry cloth. Small

surface scratches can usually be removed by gently rubbing them out with very fine steel wool (4/0 grade) and applying oil to the entire panel. Very deep scratches, dents or other serious damage should be repaired only by a qualified furniture refinisher.

Caution: Improper storage of wiping rags could result in spontaneous combustion. They should be spread out to dry in a well-ventilated area before storage or disposal.

IN CASE OF TROUBLE

A JBL loudspeaker system responds with verbatim accuracy to the signal supplied by the audio power source; it will therefore reproduce extraneous noises just as accurately as it reproduces desired program material. Noise seldom originates in the loudspeaker system. Its presence usually indicates that one of the other components of the music system, or the program material itself, is faulty. In rare instances when something does go wrong with the loudspeaker system, one or more of the component loudspeakers will stop working altogether or a distinct rattling or scraping sound (indicating a rubbing voice coil) will be heard whenever the system is operating.

If one channel of a stereo installation is not operating, examine the loudspeaker wiring and check the balance control. If wiring instructions were followed correctly, if the connections are clean and tight, and if centering the balance control does not remedy the situation, reverse the right and left loudspeaker connections at the amplifier, taking care to turn the amplifier off before each connection or disconnection. If the previously non-functional channel operates, the amplifier or one of the component program sources (tuner, phono, tape deck, etc.) is malfunctioning. In the event that the system channel is still inoperative, it is probably defective.

To determine whether the defect lies in the amplifier or in one of the component program sources (after verifying that the loudspeaker systems are not defective) reverse the right and left cables from the program source at the amplifier. If the original channel is still inoperative, the amplifier is defective; if the previously inoperative channel functions, the program source is defective. If the amplifier is not faulty, alternately check each program source until the defective unit has been isolated. It is unlikely that more than one program source will be faulty at any given time.

Extraneous interference such as static or radio broadcast signals can be picked up by the component devices. When this occurs, the troublesome unit can be identified by disconnecting inputs from the receiver or amplifier until the interference stops. Again, if the interference persists with none of the input devices operating through the power source, the receiver or amplifier itself is probably defective. Shorting plugs, available from your JBL Audio Specialist, should be

inserted in unused phono inputs to help eliminate stray hum or signal pickup.

Hum may be caused by locating a turntable or tape recorder directly over or underneath the amplifier or receiver. The farther the audio power source is located from the phonograph cartridge or tape heads, the less chance there will be of picking up hum. The AC leads and shielded cables should be as widely separated as possible; AC lines should never cross cables or speaker wiring. Power line interference can be further attenuated by using a heavy duty line interference filter between the audio power source and the AC wall outlet.

Fuzzy or indistinct high pitched sounds can usually be traced to the recording itself, a defective cartridge, a worn stylus or insufficient tracking force. Problems with low frequency reproduction are usually the result of room acoustics or placement of the speaker system. Excessive bass boost or incorrect loudness compensation tend to give a muddy or "boomy" quality to reproduced music.

Acoustic feedback is the result of mechanical vibrations produced by excessive bass at very high volume levels. The loudspeaker system can produce enough energy to vibrate other objects in the room—including the record player and, by direct mechanical transmission, the stylus itself. These vibrations are reamplified again and again, producing very loud "rumble," or even a sustained howl that increases in intensity as the volume or bass control is turned up. Possible solutions: 1) locate the speaker as far as possible from the turntable, 2) adjust or replace the turntable shock mountings, 3) place the turntable on a rubber or sponge mat to further absorb vibrations. If the low frequency tone is still audible, it is probably the result of inherent turntable rumble rather than acoustic feedback.

Should your Paragon require service, remove the defective component (see COMPONENT REMOVAL) and return it to the JBL dealer from whom your Paragon was purchased. If it is not possible to contact a dealer, write directly to the JBL Service Department describing the difficulty as fully as possible. Products returned to the factory must be sent prepaid. The warranty is recognized only when the unit is repaired by JBL or an authorized JBL Service Agency and if the serial number of the unit has not been defaced or removed.

SERVICE

If you have difficulty in achieving the fine performance of which your JBL loudspeaker system is capable, consult the JBL Audio Specialist from whom the system was purchased. He is equipped with the knowledge required to provide expert advice and assistance. If for some reason the JBL dealer is unable to assist you, write directly to the JBL Technical Services Department explaining the difficulty in detail.

FOR ADDITIONAL
INFORMATION